



XCL-C500



XCL-C500C



XCL-C280



XCL-C280C



XCL-C130



XCL-C130C



XCL-C32



XCL-C32C



XCL-C30



XCL-C30C



XCL-C Series

Digital Video Camera Module

XCL-C500	(2/3-type CCD, 5M, 15 fps, monochrome)
XCL-C500C	(2/3-type CCD, 5M, 15 fps, color)
XCL-C280	(1/1.8-type CCD, 2.8M, 26 fps, monochrome)
XCL-C280C	(1/1.8-type CCD, 2.8M, 26 fps, color)
XCL-C130	(1/3-type CCD, SXGA, 31 fps, monochrome)
XCL-C130C	(1/3-type CCD, SXGA, 31 fps, color)
XCL-C32	(1/2-type CCD, VGA, 104 fps, monochrome)
XCL-C32C	(1/2-type CCD, VGA, 104 fps, color)
XCL-C30	(1/3-type CCD, VGA, 130 fps, monochrome)
XCL-C30C	(1/3-type CCD, VGA, 130 fps, color)



introduction

In response to customer demand, Sony is proud to introduce a broad selection of new XCL CameraLink Series cameras, ranging from VGA to 5M in monochrome and color versions. With their compact size and variety of resolution options, these new cameras make it easy and affordable for customers to migrate from analog to digital. The new XCL-C280 (monochrome) and XCL-C280C (color) cameras incorporate a 1/1.8-type EXview HAD CCD II™ sensor which provides high sensitivity with a 2.8M resolution.

In addition to inheriting Sony's XCL Series camera features, such as Bulk Trigger and Sequential Trigger modes, these new cameras also incorporate some unique features including Shading Correction, Defect Correction, and Temperature Readout.

These new advanced features and benefits make XCL-C Series cameras ideal for various applications such as ITS (Intelligent Transportation Systems) and sports shooting, as well as traditional machine-vision applications.

	XCL-C500	XCL-C500C	XCL-C280	XCL-C280C	XCL-C130	XCL-C130C	XCL-C32	XCL-C32C	XCL-C30	XCL-C30C
Imager sensor	2/3-type CCD		1/1.8-type CCD		1/3-type CCD		1/2-type CCD		1/3-type CCD	
Monochrome/Color	Monochrome	Color	Monochrome	Color	Monochrome	Color	Monochrome	Color	Monochrome	Color
Effective pixels (H x V)	2,456 x 2,048		1,940 x 1,460		1,296 x 966		659 x 494		659 x 494	
Cell size (µm)	3.45 x 3.45		3.69 x 3.69		3.75 x 3.75		9.9 x 9.9		7.4 x 7.4	
Output pixels (H x V, Full resolution)	2,456 x 2,058		1,940 x 1,460		1,296 x 966		658 x 494			
Frame rate	15 fps		26 fps		31 fps		104 fps		130 fps	

key features

Shading Correction

With embedded shading correction, XCL-C Series cameras minimize the uneven image intensity often caused by lighting and/or the lens. Their internal hardware processing reduces the need for external image correction that is normally performed via a frame grabber board and PC. This handy function reduces the processing load of the PC, and simplifies the processing task. In addition, these cameras are equipped with three optional lighting settings to capture clear images in varying lighting conditions.

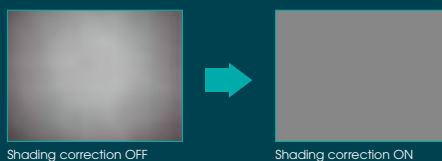

Defect Correction

XCL-C Series cameras can automatically minimize defective pixels (e.g., white and black dots) within the entire imaging area directly inside the camera. This feature helps simplify image processing.

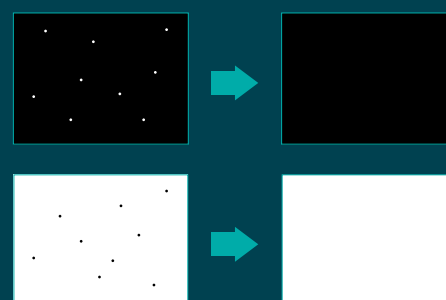

Near-infrared Sensitivity

Utilizing Sony's EXview HAD CCD II technology enables the XCL-C280 to capture clear images in NIR (near-infrared) wavelengths. When used with an infrared strobe, the camera produces outstanding picture quality especially in low light and NIR inspection applications.

Memory Channel

In addition to factory default settings, up to 16 camera parameters – including brightness, gamma, shutter, gain, and trigger mode – can be preset to suit each particular scene.



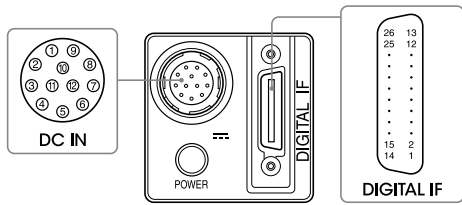

DC IN (DC power input) connector (12-pin)

Pin No.	Signal	Pin No.	Signal	Pin No.	Signal
1	Ground	5	Ground	9	GPO3 ^{*1}
2	DC 12 V	6	GPO2 ^{*1}	10	GPI2 ^{*2}
3	Ground	7	GPI3 ^{*2}	11	GPI1 ^{*2}
4	GPO1 ^{*1}	8	Ground	12	Ground

^{*1} Signal output from pin 4, 6, 9 (GPO1/2/3) of DC IN connector. This setting allows you to select from exposure signal, strobe control signal, Hi/Low fixed value, etc. The initial values of GPO1/2/3 are all Hi fixed.
^{*2} Signal output from pin 7, 10, 11 (GPI3/2/1) of DC IN connector. Function as GPI input or trigger input. The initial setting is GPI 1 for trigger input and GPI 2/3 for GPI input.

DIGITAL IF (Interface) connector (26-pin mini connector)

Pin No.	Signal	Pin No.	Signal
1	Power supply or Ground*	14	Ground
2	X0-	15	X0+
3	X1-	16	X1+
4	X2-	17	X2+
5	XCLK-	18	XCLK+
6	X3-	19	X3+
7	SerTC+	20	SerTC-
8	SerIFG-	21	SerIFG+
9	CC1-	22	CC1+
10	CC2+	23	CC2-
11	CC3-	24	CC3+
12	CC4+	25	CC4-
13	Ground	26	Power supply or Ground*

* The connection differs depending on the type of camera module interface board you use. In the case of PoCL support: Both the 1st pin and 26th pin are Power supply. In the case of non-PoCL support: Both the 1st pin and 26th pin are Ground.

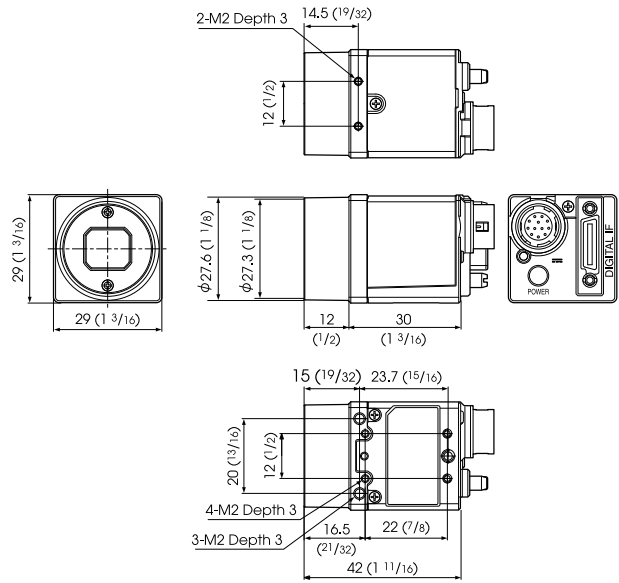

Unit: mm (inches)

VCT-333I
Tripod Adaptor



Temperature Readout

Each camera comes with an internal temperature sensor. The host device can receive temperature information by issuing a command. This eliminates the need for a separate sensor, and simplifies system configuration.

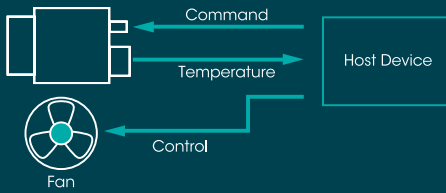

Sensitivity Control

The XCL-C Series^{*1} is equipped with a saturation signal control function to allow the amount of saturation signal charge on the CCD to be increased or decreased via software commands. For example when capturing dark objects, the user can increase the amount of saturation signal charge elevating the camera's sensitivity to improve the picture quality instead of using a long exposure time.^{*2} On the other hand, by decreasing the amount of saturation signal charge, the amount of smear can be reduced or improved.

^{*1} Excludes XCL-C130 and XCL-C130C.
^{*2} If the saturation signal charge amount exceeds the maximum that can be transferred into the vertical and horizontal registers, a transfer error will occur (e.g. smear).

Bulk Trigger Mode & Sequential Trigger Mode

These new XCL-C Series cameras feature advanced Bulk Trigger and Sequential Trigger modes in addition to a conventional trigger mode. Each camera supports 16 memory channels that can store up to 16 different camera setups (e.g., exposure, and gain).

Bulk Trigger mode allows these cameras to capture up to 16 images in rapid succession using a single software or hardware trigger.

Sequential Trigger mode allows each camera to capture a single image using successive setups stored in the memory channels with each software or hardware trigger.

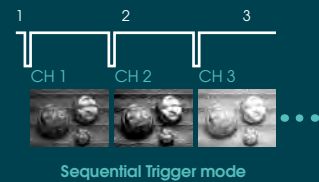

Sequential Trigger mode

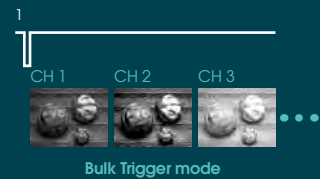

Bulk Trigger mode

Pulse Train Generator

XCL-C Series cameras are capable of outputting any rectangular wave from one of the general-purpose outputs. This pulse train can be programmed for frequencies from 0.5 Hz up to 100 KHz in 1 μs steps to control external devices such as LED lights, simplifying overall system configuration.

Look-up Table (LUT)

Each XCL-C Series camera supports a look-up table which transforms the input luminance signal into the required digital output. It supports factory presets – Linear, Negative, Binarization, and Linear Interpolation – as well as a User-defined LUT (input: 12 bits, output: 12 bits).

Trigger Noise Filtering

With a trigger line filter, these cameras can specify a valid pulse width for the trigger. This helps avoid unexpected image capture caused, for example, by triggers from insignificant noise.

XCL-C Series Specifications

www.pro.sony.eu/vision
www.image-sensing-solutions.eu

	XCL-C500	XCL-C500C	XCL-C280	XCL-C280C	XCL-C130	XCL-C130C	XCL-C32	XCL-C32C	XCL-C30	XCL-C30C	
camera	Image sensor	2/3-type progressive scan IT CCD		1/1.8-type progressive scan IT CCD		1/3-type progressive scan IT CCD		1/2-type progressive scan IT CCD		1/3-type progressive scan IT CCD	
	Image sensor (Number of effective pixels, H & V)	2,456 x 2,058		1,940 x 1,460		1,296 x 966		659 x 494			
	Cell size (H&V)	3.45 μm x 3.45 μm		3.69 μm x 3.69 μm		3.75 μm x 3.75 μm		9.9 μm x 9.9 μm		7.4 μm x 7.4 μm	
	Output pixels (H&V)	2,448 x 2,048		1,920 x 1,440		1,280 x 960		640 x 480			
	Output pixels (H x V, Full resolution)	2,456 x 2,058		1,940 x 1,460		1,296 x 966		658 x 494			
	Color filter	-	RGB color mosaic filter	-	RGB color mosaic filter	-	RGB color mosaic filter	-	RGB color mosaic filter	-	RGB color mosaic filter
	Frame rate	15 fps		26 fps		31 fps		104 fps		130 fps	
	Minimum illumination (50%)	0.5 lx (Iris: F1.4, Gain: +18 dB, Shutter: 1/15 s)	8 lx (Iris: F1.4, Gain: +18 dB, Shutter: 1/15 s)	0.5 lx (Iris: F1.4, Gain: +18 dB, Shutter: 1/25 s)	10 lx (Iris: F1.4, Gain: +18 dB, Shutter: 1/25 s)	0.5 lx (Iris: F1.4, Gain: +18 dB, Shutter: 1/30 s)	12 lx (Iris: F1.4, Gain: +18 dB, Shutter: 1/30 s)	1.0 lx (Iris: F1.4, Gain: +18 dB, Shutter: 1/60 s)	12 lx (Iris: F1.4, Gain: +18 dB, Shutter: 1/60 s)	1.5 lx (Iris: F1.4, Gain: +18 dB, Shutter: 1/90 s)	15 lx (Iris: F1.4, Gain: +18 dB, Shutter: 1/90 s)
	Sensitivity	F8 (400 lx, Gain: 0 dB)	F8 (2000 lx, Gain: 0 dB)	F5.6 (400 lx, Gain: 0 dB)	F5.6 (2000 lx, Gain: 0 dB)	F5.6 (400 lx, Gain: 0 dB)	F5.6 (2000 lx, Gain: 0 dB)	F5.6 (400 lx, Gain: 0 dB)	F5.6 (2000 lx, Gain: 0 dB)	F5.6 (400 lx, Gain: 0 dB)	F5.6 (2000 lx, Gain: 0 dB)
	S/N ratio	More than 50 dB									
Gain	Auto, Manual: 0 dB to +18 dB										
Shutter speed	2 s to 1/100,000 s										
White balance	-	One push WB, Manual	-	One push WB, Manual	-	One push WB, Manual	-	One push WB, Manual	-	One push WB, Manual	
camera features	Readout modes	Normal, Binning (2 x 1, 1 x 2, 2 x 2), Partial scan	Normal, Partial scan	Normal, Binning (2 x 1, 1 x 2, 2 x 2), Partial scan	Normal, Partial scan	Normal, Binning (2 x 1, 1 x 2, 2 x 2), Partial scan	Normal, Partial scan	Normal, Binning (2 x 1, 1 x 2, 2 x 2), Partial scan	Normal, Partial scan	Normal, Binning (2 x 1, 1 x 2, 2 x 2), Partial scan	
	Readout features	Binarization, Gamma (variable), Built-in test pattern, LUT									
	Synchronization	Hardware trigger, Software trigger									
	Trigger modes	Edge detection, Pulse width detection, Bulk Trigger, Sequential Trigger									
	Memory channel (Usersets)	16 channels									
	User memory	32 kbytes + 64 bytes x 16ch									
Other features	Shading correction, Defect correction, Temperature readout										
interface	Video data output	8, 10, 12-bit, digital	8, 10, 12-bit, Raw, digital, RGB Color	8, 10, 12-bit, digital	8, 10, 12-bit, Raw, digital, RGB Color	8, 10, 12-bit, digital	8, 10, 12-bit, Raw, digital, RGB Color	8, 10, 12-bit, digital	8, 10, 12-bit, Raw, digital, RGB Color	8, 10, 12-bit, digital	
	Digital interface	LVDS									
	Camera specification	PoCL, CameraLink® Version 1.2									
	Output data clock	80 MHz (1 tap), 40 MHz (2 tap)		81 MHz (1 tap), 40.5 MHz (2 tap)		50 MHz (1 tap), 25 MHz (2 tap)		40 MHz (1 tap), 20 MHz (2 tap)		50 MHz (1 tap), 25 MHz (2 tap)	
Digital input/output	TTL IN (x3), TTL OUT (x3)										
general	Lens mount	C mount									
	Power requirements	DC +12 V (+10.5 V to +15.0 V)									
	Power consumption	3.2 W (typical)		3.0 W (typical)		2.4 W (typical)		2.8 W (typical)			
	Operating temperature	-5°C to +45°C (23°F to +113°F)									
	Performance guarantee temperature	0°C to 40°C (32°F to +104°F)									
	Storage temperature	-30°C to +60°C (-22°F to +140°F)									
	Operating humidity	20% to 80% (no condensation)									
	Storage humidity	20% to 95% (no condensation)									
	Vibration resistance	10 G (20 Hz to 200 Hz)									
	Shock resistance	70 G									
	Dimensions (W x H x D)	29 x 29 x 30 mm (1 3/16 x 1 3/16 x 1 3/16 inches) (excluding protrusions)									
	Mass	56 g (2.0 oz)									
	Regulations	UL60950-1*, FCC Class A, CSA C22.2-No.1, IC Class A Digital Device, CE: EN61326 (Class A), AS EMC: EN61326, VCCI Class A, KCC									
Supplied accessories	Lens mount cap (1), Operating instructions (1)										

* Compliance pending (expected in/around April 2013).

Distributed by

©2012 Sony Corporation. All rights reserved. Reproduction in whole or in part without written permission is prohibited. Features and specifications are subject to change without notice. The values for weight and dimension are approximate. "SONY", "make.believe" and "EXview HAD CCD II" are registered trademarks of Sony Corporation. All other trademarks are the property of their respective owners.

SONY
make.believe